

CRAFTMADE™

MODEL# ZA2414-BZ, ZA2414-BZ-C, ZA2414-TB, ZA2414-TB-C, ZA2414-TW

INSTALLATION INSTRUCTIONS

READ IMPORTANT SAFETY TIPS BEFORE PROCEEDING WITH INSTALLATION

SAFETY TIPS

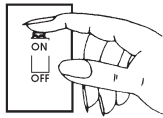

Turn fixture off! (Place wall switch in off position, if fixture has built-in switch or chain pull, switch or pull chain so fixture is off.)



Next - go to the main breaker box. If your breaker box has a breaker for the circuit the fixture is on. Simply place the breaker switch in the OFF position.

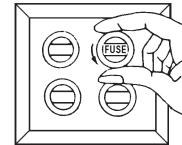

If you have a screw-in type fuse box - unscrew the fuse.

1

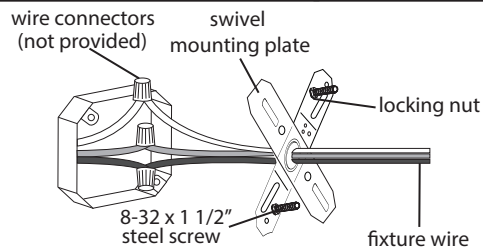

Screw 8-32 x 1 1/2" steel screws (provided) into swivel mounting plate. Head of screw to be flush with back of swivel mounting plate. Thread one 8-32 locking nut (provided) on to each screw until it is flush and tight with front of swivel mounting plate. Attach swivel mounting plate to outlet box, with screw threads facing outward, using the outlet box screws. Connect the wires from the outlet box and fixture. Attach black fixture wire to black supply wire, white fixture wire to white supply wire, and bare or green ground supply wire using wire connectors.

2

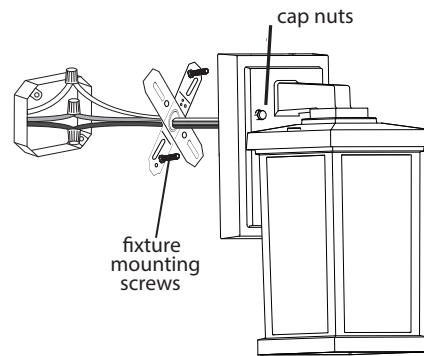

POSITION THE FIXTURE HOUSING over the fixture mounting screws and secure in place with the cap nuts provided.

3

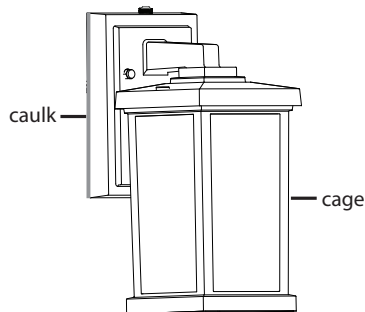

SCREW BULB into socket. Be sure to use bulb with wattage no greater than specified on fixture. NOTE: Cage does not have to be removed to install bulb.

NOTE: Fixture MUST be caulked with an acrylic caulk where fixture housing meets mounting surface. This provides a water tight seal when fixture is installed.

4

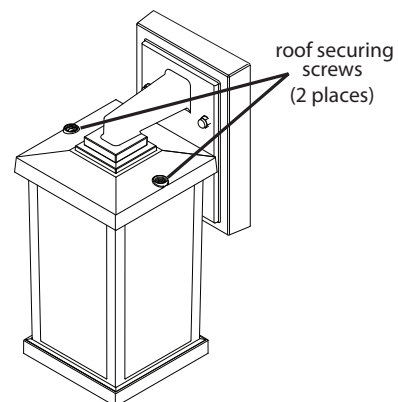

To remove cage from roof, loosen the two roof securing screws.



CLEAN ONLY WITH MILD SOAP AND WATER. AVOID SPRAYING WITH CLEANSERS, INSECTICIDES, AND PESTICIDES THAT ARE PETROLEUM BASED HYDROCARBON PRODUCTS. THESE WILL DEGRADE LUMINAIRE.