

CRAFTMADE™

READ THESE INSTRUCTIONS AND
SAVE THEM FOR FUTURE USE



Augusta

Installation Guide

For Model:
AUG60

WARNING:
**DC Motor will not
operate until
blades are installed**

Table of Contents:

Safety Tips. pg. 2
Unpacking Your Fan. pg. 3
Parts Inventory. pg. 3
Installation Preparation. pg. 4
Hanging Bracket Installation. pg. 4
Fan Assembly. pgs. 5 - 6
Wiring. pg. 7
Canopy Assembly. pg. 8
Blade Assembly. pg. 8
Light Kit Assembly. pg. 9
Handheld Remote Control Assembly. pg. 10
Automated Learning Process./
 Activating Code. pg. 11
Remote/Wall Control Operation. pg. 12
Testing Your Fan. pg. 12
Troubleshooting. pg. 13
Warranty. pg. 13
Parts, Replacement or Technical Assistance. pg. 13



net weight of fan: 16.29lb (7.39 kg)

SAFETY TIPS.

WARNING: To reduce the risk of electrical shock, turn off the electricity to the fan at the main fuse box or circuit panel before you begin the fan installation or before servicing the fan or installing accessories.

1. **READ ALL INSTRUCTIONS AND SAFETY INFORMATION CAREFULLY BEFORE INSTALLING YOUR FAN AND SAVE THESE INSTRUCTIONS.**

CAUTION: To avoid personal injury, the use of gloves may be necessary while handling fan parts with sharp edges.

2. Make sure all electrical connections comply with Local Codes or Ordinances, the National Electrical Code, and ANSI/NFPA 70-1999. If you are unfamiliar with electrical wiring or if the house/building wires are different colors than those referred to in the instructions, please use a qualified electrician.
3. Make sure you have a location selected for your fan that allows clear space for the blades to rotate, and at least seven (7) feet (2.13 meters) of clearance between the floor and the fan blade tips. The fan should be mounted so that the tips of the blades are at least thirty (30) inches (76 centimeters) from walls or other upright structures.
4. The outlet box and ceiling support joist used must be securely mounted, and capable of supporting at least 35 pounds (16 kilograms). The outlet box must be supported directly by the building structure. Use only CUL in Canada or UL in USA listed outlet boxes marked "FOR FAN SUPPORT."

WARNING: To reduce the risk of fire, electrical shock, or personal injury, mount to the outlet box marked "Acceptable for Fan Support of 15.9 kg (35 lb) or less," and use the mounting screws provided with the outlet box. Most outlet boxes commonly used for the support of lighting fixtures are not acceptable for fan support and may need to be replaced. Consult a qualified electrician if in doubt.

WARNING: To reduce the risk of fire, electrical shock, or personal injury, wire connectors provided with this fan are designed to accept only one 12 gauge house wire and two lead wires from the fan. If your house wire is larger than 12 gauge or there is more than one house wire to connect to the corresponding fan lead wires, consult an electrician for the proper size wire connectors to use.

5. Electrical diagrams are for reference only.
6. After installation is complete, check that all connections are absolutely secure.
7. After making electrical connections, spliced conductors should be turned upward and pushed carefully up into the outlet box. The wires should be spread apart with the grounded conductor and the equipment-grounding conductor on opposite sides of the outlet box.

WARNING: To reduce the risk of serious bodily injury, DO NOT use power tools to assemble any part of the fan, including the blades.

WARNING: To reduce the risk of fire or electrical shock, do not use this fan with any solid state speed control device or control fan speed with a full range dimmer switch. [Using a full range dimmer switch to control fan speed will cause a loud humming noise from fan.]

8. Do not operate the reverse switch until the fan has come to a complete stop. [**Note:** If using remote control with reverse capability, reverse fan blade direction only when on LOW speed.]
9. Do not insert anything between the fan blades while they are rotating.

WARNING: To reduce the risk of personal injury, do not bend the blade arms during assembly or after installation.

WARNING: To avoid personal injury or damage to the fan and other items, be cautious when working around or cleaning the fan.

10. Do not use water or detergents when cleaning the fan or fan blades. A dry dust cloth or lightly dampened cloth will be suitable for most cleaning.

WARNING: To reduce the risk of personal injury, use **only** parts provided with this fan. **The use of parts OTHER than those provided with this fan will void the warranty.**

WARNING: This fan MUST be installed with the safety cable provided with the fan. Failure to use the safety cable provided may result in personal injury, damage to the fan or damage to other property.

11. Light kit is dimmable to 10% with select dimmers.

Changes or modifications not approved by the party responsible for compliance could void the user's authority to operate the equipment. [The equipment refers to the remote and/or wall control and/or LED light kit.]

NOTE: This equipment has been tested and found to comply with the limits for a Class B digital device, pursuant to Part 15 of the FCC Rules. These limits are designed to provide reasonable protection against harmful interference in a residential installation. This equipment generates, uses and can radiate radio frequency energy and, if not installed and used in accordance with the instructions, may cause harmful interference to radio communications. However, there is no guarantee that interference will not occur in a particular installation. If this equipment does cause harmful interference to radio or television reception, which can be determined by turning the equipment off and on, the user is encouraged to try to correct the interference by one or more of the following measures:

- * Reorient or relocate the receiving antenna.
- * Increase the separation between the equipment and receiver.
- * Connect the equipment into an outlet on a circuit different from that to which the receiver is connected.

Consult the dealer or an experienced radio/TV technician for help.

The LED light kit complies with Part 15 of the FCC Rules. Operation is subject to the following two conditions: (1) this LED light kit may not cause harmful interference, (2) this LED light kit must accept any interference received, including interference that may cause undesired operation.

Distributed by: Craftmade, 3901 South 20th Avenue, DFW Airport, TX, 75261; 1-800-486-4892

NOTE: The important safety precautions and instructions appearing in the manual are not meant to cover all possible conditions and situations that may occur. It must be understood that common sense and caution are necessary factors in the installation and operation of this fan.

1. Unpacking Your Fan.

Carefully open the packaging. Remove items from Styrofoam inserts. Remove motor housing and place on carpet or Styrofoam to avoid damage to finish. Do not discard fan carton or Styrofoam inserts should this fan need to be returned for repairs.

Check against parts inventory that all parts have been included.

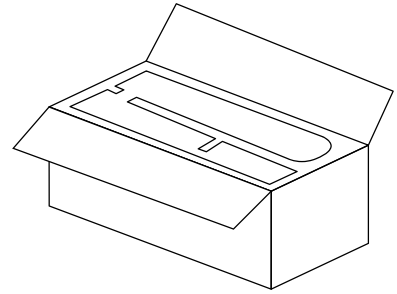

2. Parts Inventory.

- a.** canopy. 1 piece
- b.** hanging bracket. 1 piece
- c.** downrod and hanging ball. 1 piece
- d.** motor housing. 1 piece
- e.** light kit fitter. 1 piece
- f.** yoke cover. 1 piece
- g.** blade. 4 pieces
- h.** fitter plate. 1 piece
- i.** canopy cover. 1 piece
- j.** wall control. 2 pieces
- k.** remote control cover. 1 piece
- l.** plate. 1 piece
- m.** faceplate. 3 pieces
- n.** hardware packs

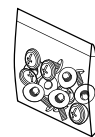
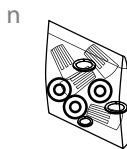
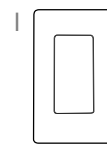
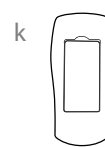
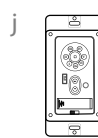
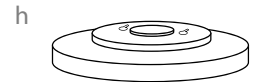
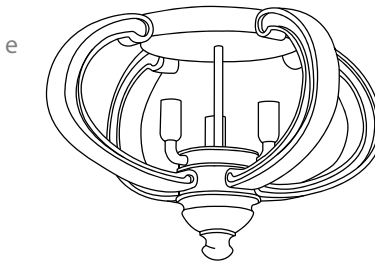
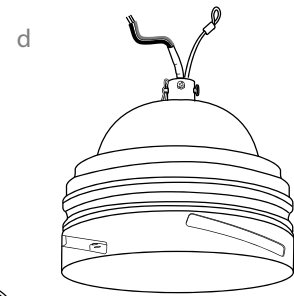
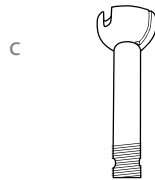
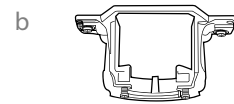
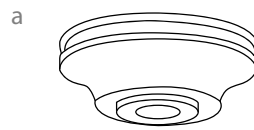

! IMPORTANT REMINDER: You must use the parts provided with this fan for proper installation and safety. **!**

bulbs required:
4 x 4 watt LED bulbs,
(included)



3. Installation Preparation.

To prevent personal injury and damage, ensure that the hanging location allows the blades a clearance of 7 feet (2.13m) from the floor and 30in. (76cm) from any wall or obstruction.

This fan is suitable for room sizes up to 400 square feet (37.2 square meters).

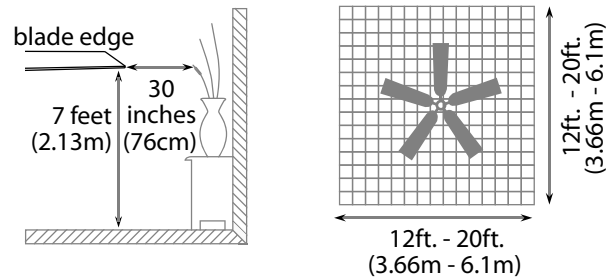

This fan can be mounted with a **downrod** on a regular (no-slope) or vaulted ceiling. The hanging length can be extended by purchasing a longer downrod (0.5in./1.27cm diameter). Other installation, such as **flushmount**, is *not* available for this fan.

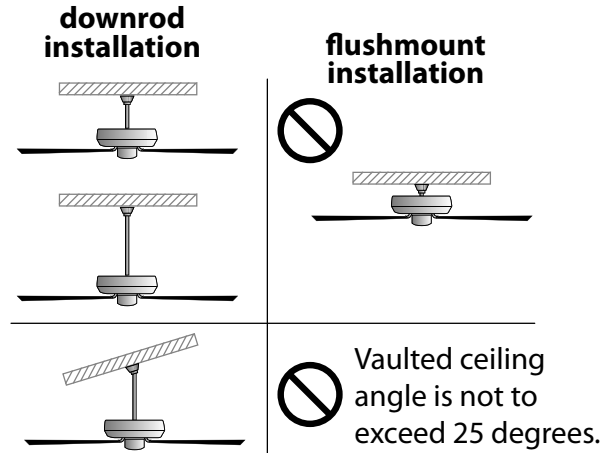

Installation requires these tools:

Phillips screwdriver, flathead screwdriver, short head screwdriver, offset screwdriver, adjustable pliers or wrench, stepladder, wire cutters, and rated electrical tape

4. Hanging Bracket Installation.

Turn off circuit breakers to current fixture from breaker panel and be sure operating light switch is turned to the OFF position.

WARNING: Failure to disconnect power supply prior to installation may result in serious injury.

Remove existing fixture.

WARNING: When using an existing outlet box, be sure the box is securely attached to the building structure and can support the full weight of the fan. Ensure it is clearly marked "Suitable for Fan Support." If not, it must be replaced with an approved outlet box. Failure to do so can result in serious injury.

CAUTION: Be sure outlet box is grounded and that a ground wire (**GREEN** or bare) is present.

Install hanging bracket to outlet box using original screws, spring washers and flat washers provided with new or original outlet box.* If installing on a vaulted ceiling, face opening of hanging bracket towards high point of ceiling. Arrange electrical wiring around the back of the hanging bracket and away from the bracket opening.

***Note:** It is very important that you use the proper hardware when installing the hanging bracket as this will support the fan.

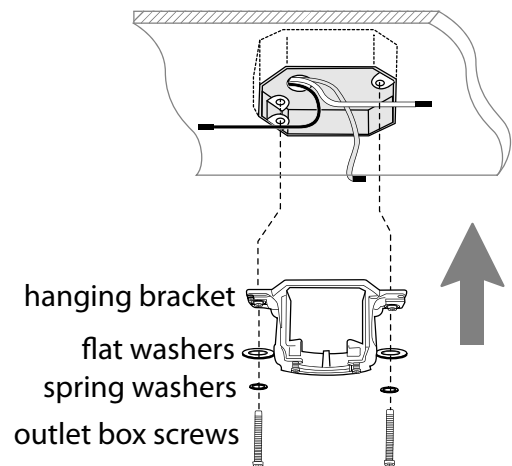
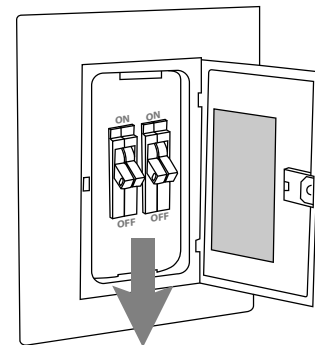

5. Fan Assembly.

Remove hanging ball from downrod provided by loosening set screw on hanging ball. Lower hanging ball and remove stop pin and then slide hanging ball off of the downrod. [Refer to **diagram 1**.]

Loosen yoke set screws and nuts at top of motor housing. Remove pin and clip from motor housing yoke. [Refer to **diagram 2**.]

Tip: To prepare for threading electrical wires through downrod, apply a small piece of electrical tape to the ends of the electrical wires--this will keep the wires together when threading them through the downrod. [Refer to **diagram 2**.]

Determine the length of downrod you wish to use. Thread safety cable and electrical wires through threaded end of downrod and pull extra wire slack from the upper end of the downrod. [Refer to **diagram 2**.]

Thread downrod into the motor housing yoke until holes for pin and clip in downrod align with holes in yoke--*make sure wires do not get twisted*. Re-insert pin and clip that were previously removed. Tighten yoke set screws and nuts securely. [Refer to **diagram 2**.]

Slide yoke cover, canopy cover and canopy over downrod. [Refer to **diagram 3**.] (**Note:** Canopy cover must be turned with shiny side *toward* the motor housing.)

Thread safety cable and wires through hanging ball and then slide hanging ball over downrod--the top of the downrod should be noted as having a set screw hole; use this hole when setting the set screw. Insert stop pin into top of downrod and raise hanging ball. Be sure stop pin aligns with slots on the inside of the hanging ball. Tighten set screw securely. [Refer to **diagram 4**.]

WARNING: Failure to tighten set screw (on hanging ball) completely could result in the fan becoming loose and possibly falling.

["Fan Assembly" continued on next page.]

NOTE: The important safety precautions and instructions appearing in the manual are not meant to cover all possible conditions and situations that may occur. It must be understood that common sense and caution are necessary factors in the installation and operation of this fan.

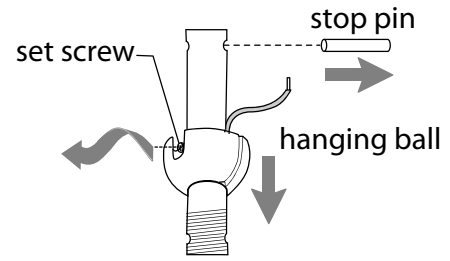

diagram 1

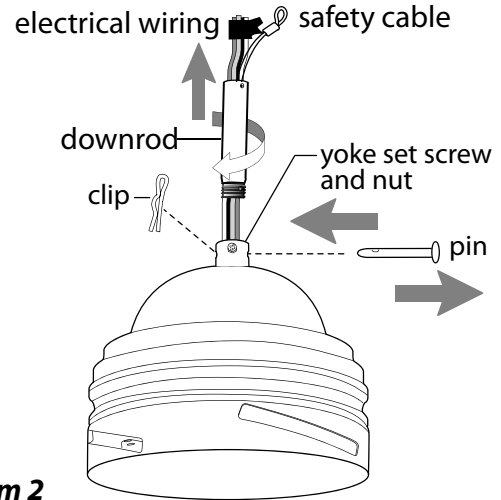

diagram 2

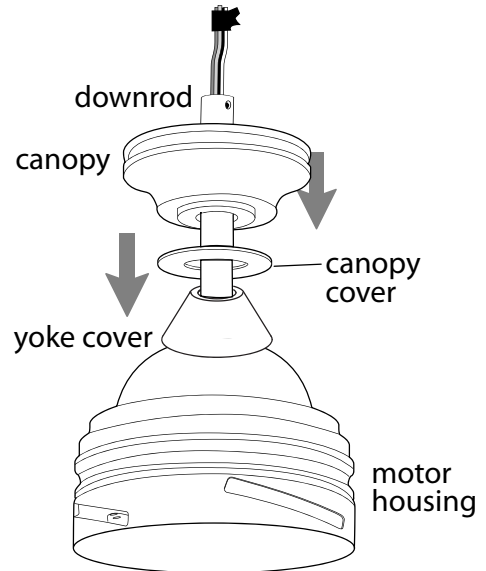

diagram 3

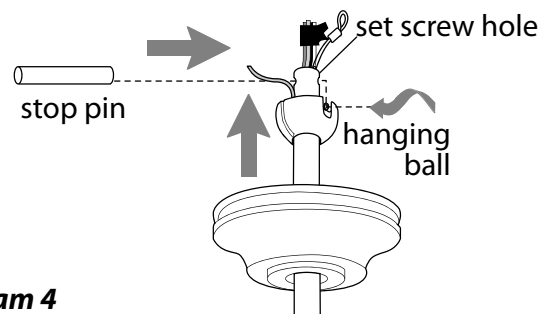

diagram 4

5. Fan Assembly. (cont.)

With the hanging bracket secured to the outlet box and able to support the fan, you are now ready to hang your fan. Grab the fan firmly with two hands. Slide downrod through opening in hanging bracket and let hanging ball rest on the hanging bracket. Turn the hanging ball slot until it lines up with the hanging bracket tab.

WARNING: Failure to align slot in hanging ball with tab in hanging bracket may result in serious injury or death.

Tip: Seek the help of another person to hold the stepladder in place and to help lift the fan up to you once you are set on the ladder.

Find a secure attachment point (wood ceiling joist highly recommended) and secure safety cable. It will be necessary to use a heavy duty wood screw, washer and lock washer (not supplied) with the safety cable loop. If necessary, adjust the loop at the end of the safety cable. The loop at the end of the safety cable should just fit over the threads on the wood screw. *Test safety cable by pulling on loose end of cable with pliers. If the safety cable slips, the loop must be adjusted tighter.* Extra cable slack can be left in ceiling area.

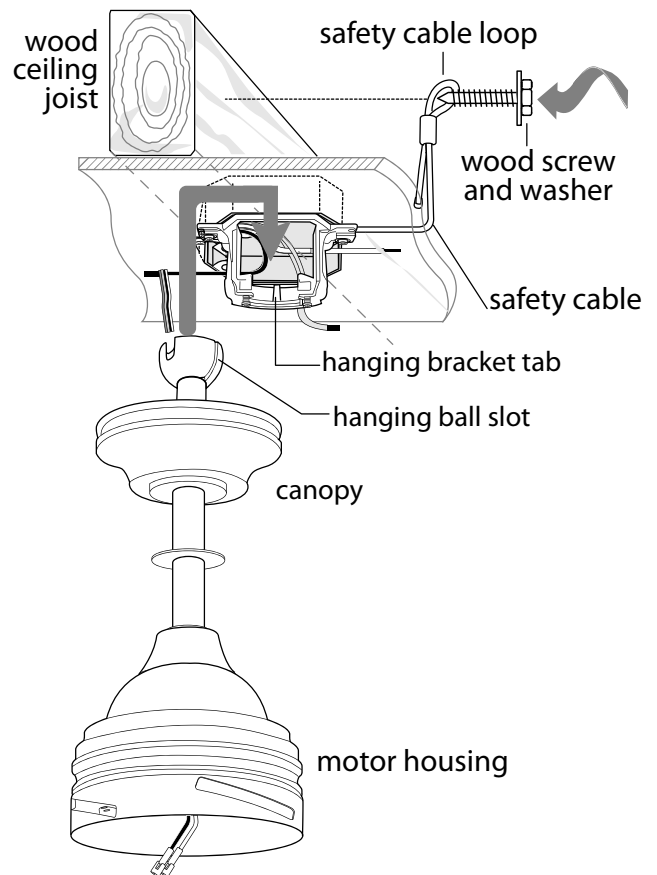

6. Wiring.

WARNING: Turn off circuit breakers to current fixture from breaker panel and be sure switch is turned to the OFF position.

CAUTION: Be sure outlet box is properly grounded or that a ground wire (**GREEN** or Bare) is present.

Make sure all electrical connections comply with Local Codes or Ordinances and the National Electrical Code. If you are unfamiliar with electrical wiring or if the house/building wires are different colors than those referred to below, please use a qualified electrician.

Note: Excess lead wire length from the fan can be cut to the desired length and then stripped.

When fan is secured in place on the hanging bracket, electrical wiring can be made as follows:

Connect **BLACK** wire from fan to **BLACK** wire from ceiling with wire connector provided.

Connect **WHITE** wire from fan to **WHITE** wire from ceiling with wire connector provided.

Connect all **GROUND (GREEN)** wires together from fan to **BARE/GREEN** wire from ceiling with wire connector provided.

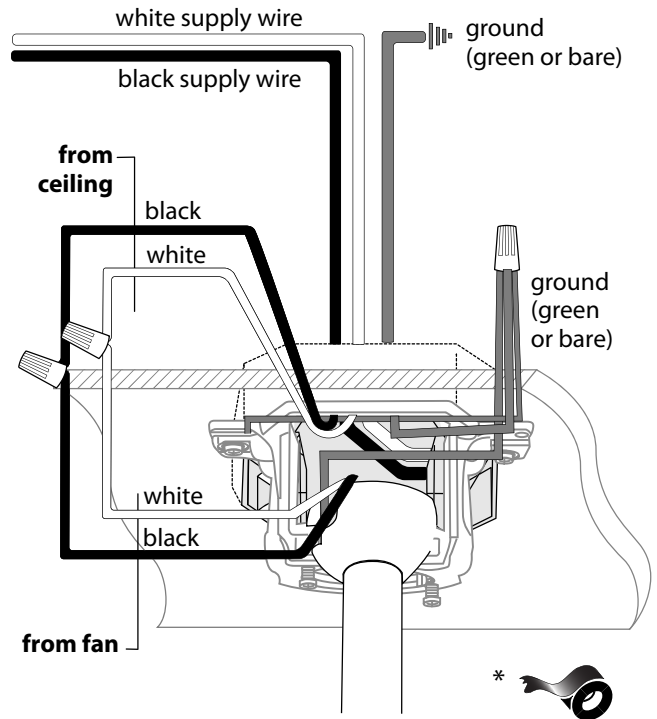

(wiring for fan)

* Wrap each wire connector separately with electrical tape as an extra safety measure.

[PLEASE NOTE: Wall and/or handheld remote control must be used for fan to operate. If you do **not** wish to use the wall control, please proceed to Section 7 on the following page to continue with fan installation.]

To install wall control, remove existing wall switch. Wire one of the wall controls with wire connectors provided **as shown in diagram at right.**

*Wrap each wire connector separately with electrical tape as an extra safety measure. Gently push wires and taped wire connectors into outlet box.

Install one 12-volt battery (included) in wall control.

IMPORTANT: Wall control will not function unless battery is installed.

WARNING: Battery is to be inserted with the correct polarity.

Since this fan comes with an LED light kit, the dimmer switch (labeled **DIM** and **ON**) has been pre-set to the "ON" position (**DIM**). If you do not wish to have dimming capability, please move the switch to the "OFF" position (**ON**).

Select a faceplate (almond or white) and press firmly onto front of wall control. Attach wall control to outlet box and secure with screws from original wall switch. Attach wall plate (included) to wall control using 2 screws provided with the wall control.

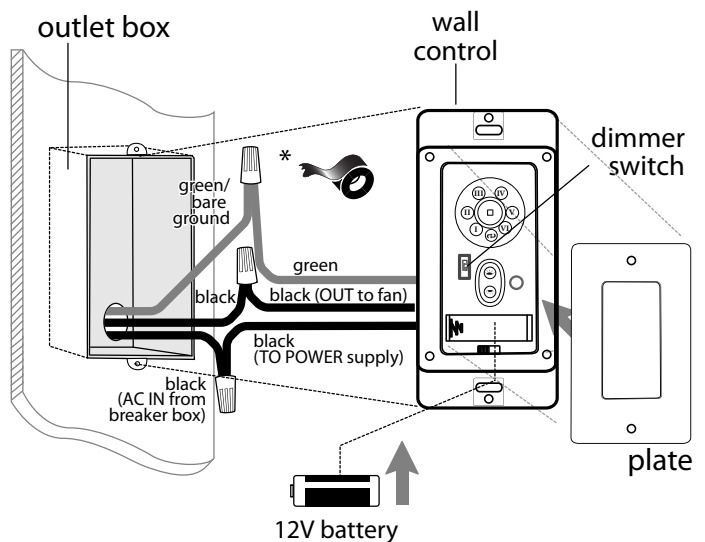

(wiring for wall control)

7. Canopy Assembly.

Locate 2 screws on underside of hanging bracket and remove screw closest to the open end of the hanging bracket. Partially loosen the other screw. Lift canopy to hanging bracket. Place rounded part of slotted hole in canopy over loosened screw in hanging bracket and push up. Twist canopy to lock. Re-insert screw that was removed, and then tighten both screws securely. Slide canopy cover up to canopy, aligning rounded part of slotted holes in canopy cover with screw heads in bottom of canopy. Turn cover to the right (clockwise) until it stops.

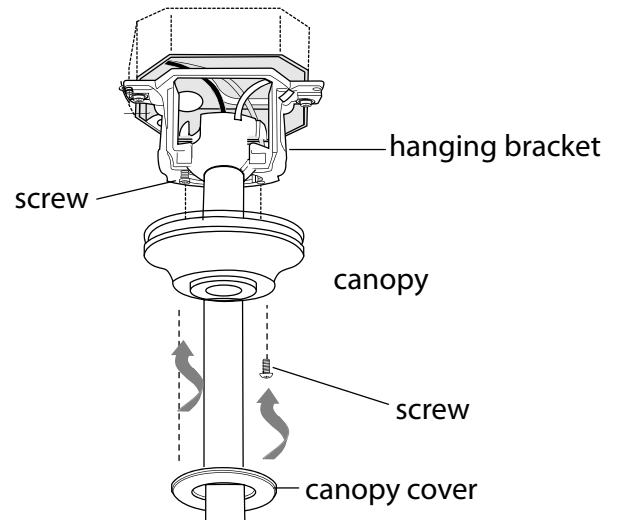

8. Blade Assembly.

WARNING: To reduce the risk of serious bodily injury, DO NOT use power tools to assemble the blades. If screws are overtightened, blades may crack and break.

Time Saver: Washers for blade screws can be set on each blade screw prior to installing blades.

Locate 12 blade attachment screws and washers in hardware pack. Slide blade through one of the narrow, rectangular openings on motor housing, aligning holes in blade with holes in blade arm (**located on the underside of the motor housing**)--refer to drawing at right. Insert 3 blade attachment screws (along with washers) with fingers first and tighten screws securely with a Phillips screwdriver. Repeat procedure for each remaining blade.

Note: Tighten blade arm screws twice a year.

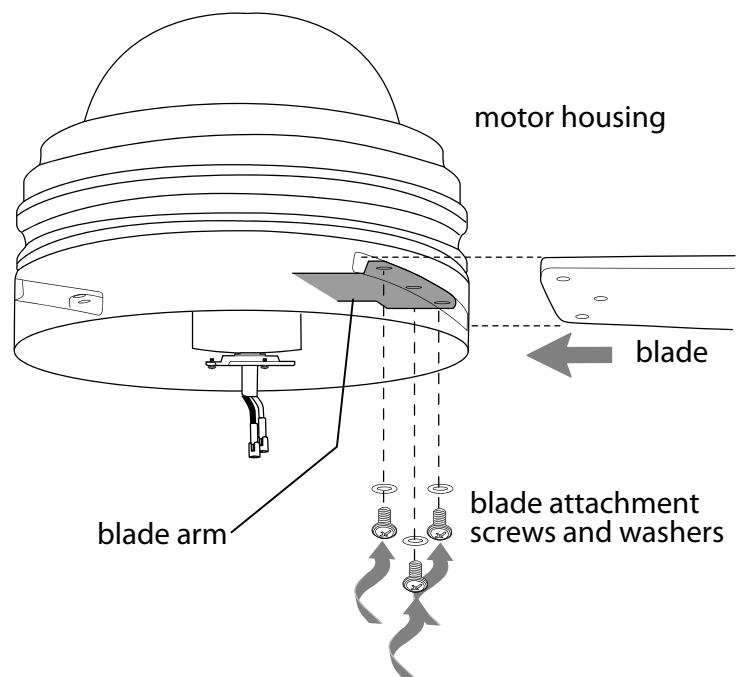

9. Light Kit Assembly.

Remove 1 screw from motor plate on underside of motor housing and partially loosen the other 2 screws.

Align slotted holes in fitter plate with loosened screws in motor plate allowing molex connections to come through center hole in fitter plate. Twist fitter plate to lock. Re-insert screw that was previously removed and securely tighten all 3 screws with Phillips screwdriver.

Connect **WHITE** wire from motor housing to **WHITE** wire from light kit fitter. Connect **BLACK** wire from motor housing to **BLACK** wire from light kit fitter. Be sure molex connections snap together securely.

Remove 4 screws from small posts located on underside of fitter plate. Raise light kit fitter to posts and align holes in light kit fitter with holes in posts. Attach light kit fitter with the 4 screws that were just removed.

Install four 4 watt LED bulbs (included).
Important: When replacing bulbs, please allow bulb(s) and light kit fitter to cool down before touching them.

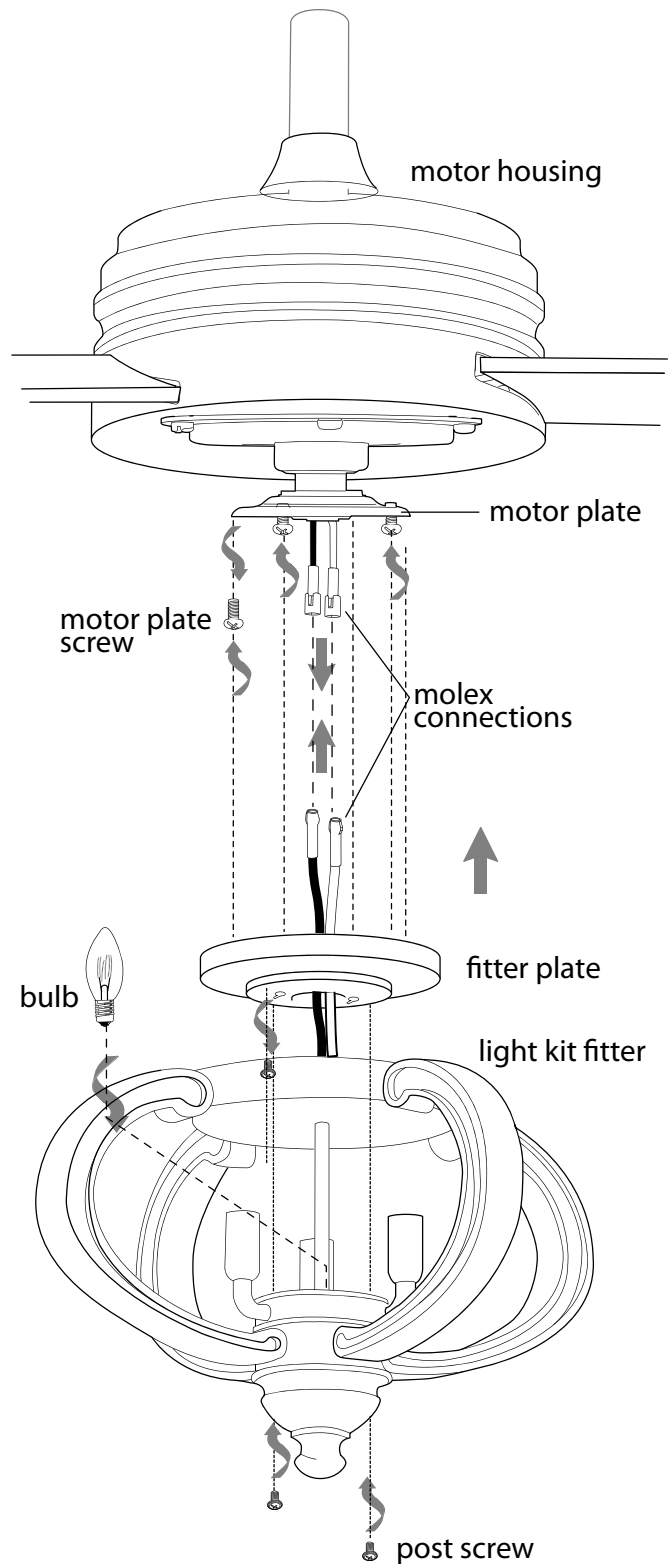

10. Handheld Remote Control Assembly.

*IN ORDER TO USE THE HANDHELD REMOTE CONTROL, PLEASE CONTINUE WITH SECTION 10 for remote control assembly instructions. If you have already installed the wall control but do **not** wish to use the handheld remote control, please proceed to Section 11.*

Gently pull on remote control cover to separate top and bottom parts. [Refer to **diagram 1**.]

In order to use wall control as a handheld remote control, cut each wire on wall control (that was not previously used)--use wire cutters to cut off each wire as close to the wall control as possible. [Refer to **diagram 2**.]

Install one battery (included) in wall control. [Refer to **diagram 2**.]

WARNING: Battery is to be inserted with the correct polarity.

Since this fan comes with an LED light kit, the dimmer switch (labeled **ON** and **D**) has been pre-set to the "ON" position (**ON**). If you do not wish to have dimming capability, please move the switch to the "OFF" position (**D**). [Refer to **diagram 2**.]

Attach **black faceplate** to front of wall control; press down firmly. [Refer to **diagram 3**.]

Align holes in wall control with posts located on *inside* of TOP part of remote control cover and press together firmly. Place wall control into BOTTOM part of remote control cover, aligning posts in top of remote control cover with post holes in the bottom. [Refer to **diagram 3**.] (**NOTE:** Make sure to align narrower ends of remote control cover before closing.) Squeeze top and bottom of remote control cover together until you hear a click at each end, indicating that the remote control cover has closed completely.

IMPORTANT: Store the handheld remote control away from excess heat or humidity. To prevent damage to handheld remote control, remove the battery if remote control will not be used for long periods.

NOTE: Remove battery with low or no charge and dispose of properly

CAUTION: "DO NOT DISPOSE OF BATTERIES IN FIRE, BATTERIES MAY EXPLODE OR LEAK." - When disposing of household alkaline batteries, it is best to check with your local and state recycling or household hazardous waste coordinators concerning the specifics of the program in your area. You may also locate a recycling center by calling 1-800-8-BATTERY or 1-877-2-RECYCLE or visit www.epa.gov/epawaste/index.htm or www.earth911.org for more information.

WARNING: Choking Hazard - Small parts. Keep battery away from children.

WARNING: Batteries are NOT rechargeable. Non-rechargeable batteries are not to be recharged.

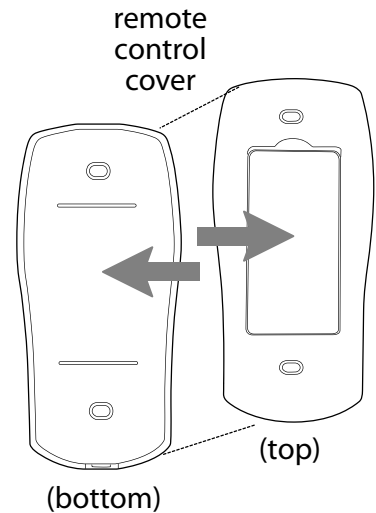

diagram 1

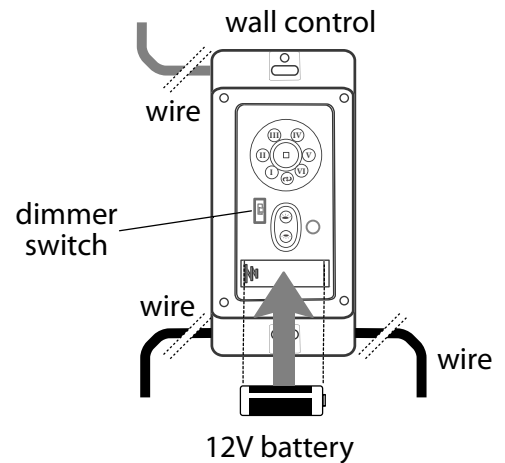

diagram 2

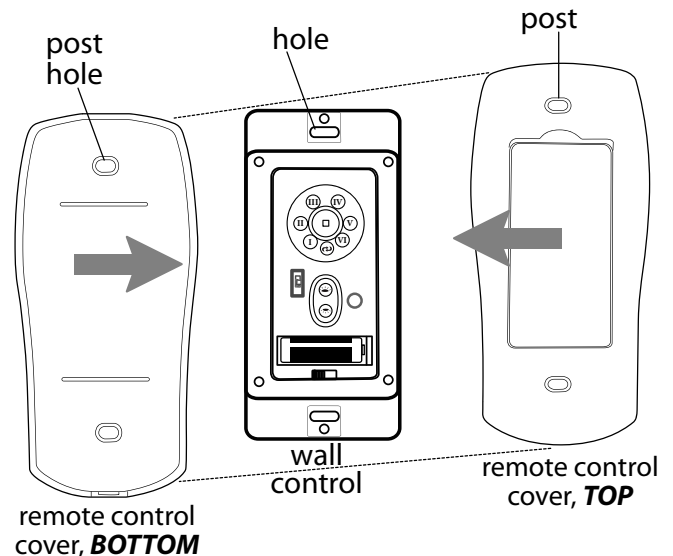

diagram 3

11. Automated Learning Process./Activating Code.

CAUTION: The wall and/or handheld remote control can be programmed to multiple receivers or fans. If this is not desired, turn wall switch off to any other programmable receiver or fan.

Restore electrical power and then, if using wall control, set slider switch on wall control to the ON position. Within 60 seconds of turning on the wall control, press and hold the fan **SET** button on the wall control for 5 seconds or until light blinks twice.

Turn power off again for at least 5 seconds and then turn power back on. Within 60 seconds of restoring the power, press and hold the fan **SET** button on the handheld remote control for 5 seconds or until light blinks twice.

Test the light and fan functions to confirm the learning process is complete -- see Section 13 on the following page.

Select a faceplate (**almond or white**) and press firmly onto front of wall control that was previously installed to the outlet box on the wall. [Refer to **diagram 1**.]

Attach **black faceplate** to front of handheld remote control; press down firmly. [Refer to **diagram 2**.]

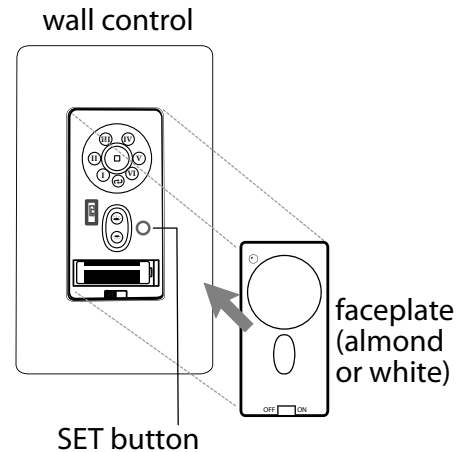

diagram 1

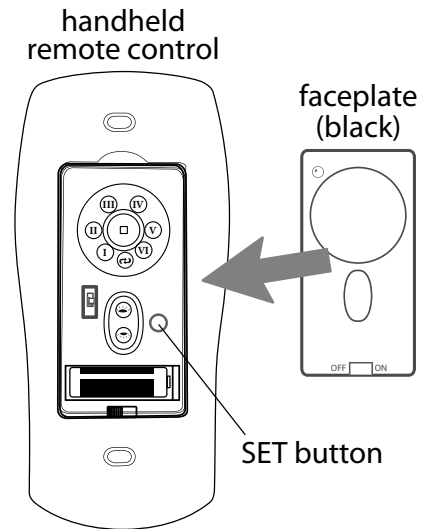
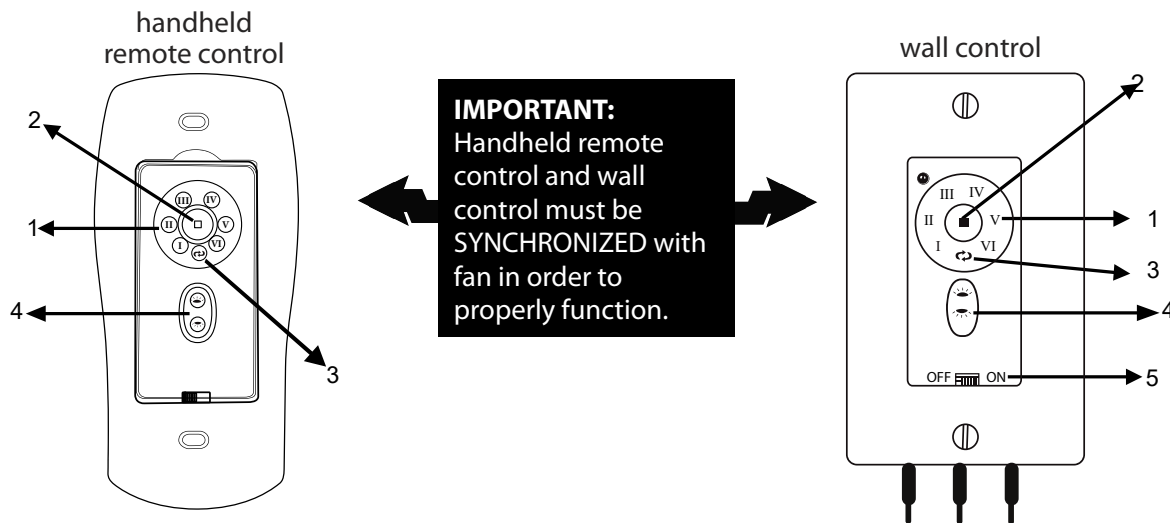

diagram 2

12. Remote/Wall Control Operation.



- Fan **SPEED** control buttons--1: Use to control the ceiling fan speed 1-6
 Fan **OFF** button--2: Use to turn the fan off
REVERSE function button--3: Use to control fan direction
LIGHTING button--4: Use to control down-light and up-light (if applicable)
ON/OFF slider switch--5: [Wall control only] Use to turn wall control ON or OFF

IMPORTANT: The Automated Learning Process takes approximately 5 minutes to complete. Please **leave the fan "ON"** for the duration of the 5-minute programming and **do NOT use the remote control or turn off the power** during this time. The fan will **cycle through ALL SIX (6) speeds in forward and reverse** and will **then stop automatically** after the learning process is complete.

13. Testing Your Fan.

It is recommended that you test fan before finalizing installation. Restore power from circuit box and light switch (if applicable). Test wall control (optional installation) by locating ON/OFF slider switch on wall control, then set to the ON position. Test light and dimmer function and then test fan speeds. Next, locate handheld remote control. Test fan speeds with the different fan speed buttons (I - VI) on handheld remote control. Test the light ON/OFF function by pressing the button; test the dimmer function by pressing the button and holding it down for 1 second. If the remote control operates all of the functions of the fan, battery has been installed correctly. If the wall and/or remote controls do (does) not operate all of the fan functions, refer to "Troubleshooting" section to solve any issues before contacting Customer Service.

Fan *must* be on **LOW** before setting the fan in reverse. Use button to recirculate air depending on the season. A ceiling fan will allow you to raise your thermostat setting in summer and lower your thermostat setting in winter without feeling a difference in your comfort.

NOTE: If the wall control/handheld remote control interferes with other appliances, activate a new code on the wall control/ handheld remote control by **turning the power off first**. Go back to the instructions for the SET button in Section 11 (page 11).

IMPORTANT: Handheld remote control and wall control must be synchronized with fan in order to properly function.

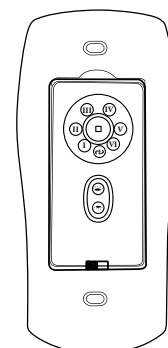
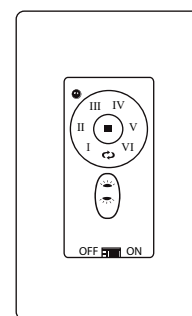

Troubleshooting.

WARNING: Failure to disconnect power supply prior to troubleshooting any wiring issues may result in serious injury.

Problem: Fan fails to operate.

Solutions:

1. Check power to wall switch/wall control.
2. Verify that wall control (optional use) is wired properly.
3. Check to be sure fan is wired properly.
4. Learning process between fan, handheld remote control and, if applicable, wall control may not have been successful and code was not activated. Turn off power and repeat instructions for SET button in Section 11 (page 11).
5. Check that red light on handheld remote control turns on when a button is pressed indicating that the battery is good.

Problem: Light kit not lighting.

Solutions:

1. Check bulb is installed correctly.
2. Check wall switch to fan/wall control.
3. Verify that molex connections in LED light kit are connected properly.
4. Check to be sure wires in canopy are wired properly.
5. Learning process between fan, handheld remote control and, if applicable, wall control may not have been successful and code was not activated. Turn off power and repeat instructions for SET button in Section 11 (page 11).

Problem: Fan and light fail to operate with remote control and/or wall control.

Solutions:

1. Check battery power to handheld remote control and/or wall control.
2. Learning process between fan, handheld remote control and, if applicable, wall control may not have been successful and code was not activated. Turn off power and repeat instructions for SET button in Section 11 (page 11).
3. If using optional wall control, check that battery in wall control is still good.

Problem: Fan wobbles.

Solutions:

1. Use the balancing kit provided in one of the hardware packs. *If no blade balancing kit is provided, please call Customer Support, 1-800-486-4892, to request one.*
2. Check to be sure set screw(s) on motor housing yoke is (are) tightened securely.
3. Check to be sure set screw on hanging ball is tightened securely.

Warranty.

CRAFTMADE LIMITED LIFETIME WARRANTY:

CRAFTMADE warrants this fan for use as intended under the following provision: CRAFTMADE will replace any fan which has faulty performance due to a defect in material or workmanship or fails to operate satisfactorily when failure results from normal use.

Contact Craftmade Customer Service at **1-800-486-4892, Option 1** or via email at **customerservice@craftmade.com**.

In the event a product is no longer available, CRAFTMADE will make best efforts to offer a comparable product or credit towards another CRAFTMADE fan.

The purchaser shall be responsible for all costs incurred in the removal and reinstallation.

This warranty does not apply when damage from mechanical, physical, electrical or water abuse results in causing the malfunction. Deterioration of finishes or other parts due to time or exposure to salt air is specifically exempted under this warranty. Shades and light bulbs are not covered by this warranty but will be replaced if found broken at time of purchase.

Neither CRAFTMADE nor the manufacturer will assume any liability resulting from improper installation or use of this product. In no case shall the company be liable for any consequential damages for breach of this, or any other warranty expressed or implied whatsoever. This limitation as to consequential damages shall not apply in states where prohibited.

Parts, Replacement or Technical Assistance.

For parts, replacement, technical assistance or additional information, please have the fan model number, name or picture available and contact Craftmade in one of the following ways
Customer Support:

1-800-486-4892, Option 1

Technical Support:

1-800-486-4892, Option 2

Email:

customerservice@craftmade.com

www.craftmade.com

CRAFTMADE™